

**CITY OF MANHATTAN BEACH  
DEPARTMENT OF COMMUNITY DEVELOPMENT**

**TO:** Parking and Public Improvements Commission

**FROM:** Marisa Lundstedt, Director of Community Development

**BY:** Eric Haaland, Associate Planner

**DATE:** September 22, 2016

**SUBJECT:** Consideration of an Encroachment Permit Appeal Amendment to Allow Retractable Awnings in the Public Right-of-Way – 117 Manhattan Beach Boulevard (The Strand House)

**RECOMMENDATION:**

Staff recommends that the Commission **REVIEW** the request at 117 Manhattan Beach Boulevard, The Strand House, to install retractable awnings in the Manhattan Beach Boulevard public right of way, and **PROVIDE** a recommendation to the City Council.

**BACKGROUND:**

A major remodel to an existing restaurant building (Strand House) on the subject property was approved by the City Council in 2011. The approval included permission for two balconies with dining area to extend 5 feet into the public right-of-way over the Manhattan Beach Boulevard sidewalk (Attachment B). City Council approval was specifically required as the encroaching balconies contain active commercial use (dining) (MBMC 7.36.170 A – Attachment D). Awnings, entries, and signs that extend into the right-of-way no more than the 3 feet are commonly approved by Staff. Resolution No. 6304, condition No. 2, allows the dining balconies, but prohibits any other right-of-way encroachments. The amendment request for the awnings must therefore be approved by the City Council with a recommendation from the Parking and Public Improvements Commission (PPIC).

**DISCUSSION:**

The submitted plan shows two new fabric awning structures being attached to the upper front wall of an existing two-story restaurant building, capable of extending over the existing 5-foot by 16-foot balcony dining areas, and receding back to the face of the wall. An awning such as this, that extended only 3 feet, and absent the special existing balcony approval, would involve only a routine Staff-issued permit. Section 7.36.170 of the Municipal Code (attached) requires Council approval of all but very standard commercial encroachment permits. The unique aspect of the balcony encroachment approval led to the condition that restricted any additional encroachment items.

The applicant's attached request indicates the reasoning for the proposal is to provide safer cover for balcony diners than the current umbrellas provide. The awnings shown in the attached

material have a low visual profile compared to many awnings and canopies typical of Downtown commercial encroachments. Staff suggests requiring a low profile design if the applicant's request is approved.

#### Public Input

A notice of the Parking and Public Improvement Commission meeting was mailed to all property owners within a 300-foot radius from the subject encroachment property. No public comments had been received at the time of preparation of this report.

#### CONCLUSION:

Staff recommends that the Parking and Public Improvement Commission review the awning proposal with respect to the existing balcony encroachment, and make a recommendation to the City Council as to whether an amendment to the existing Encroachment Appeal, contained in Resolution No. 6304, to allow retractable awnings to encroach 5 feet over the public right-of-way, should be approved.

#### Attachments:

- A. Vicinity Map and Photo
- B. Resolution No. 6304
- C. 2011 Background Material – MBMC 7.36.170
- D. Encroachment Code excerpt
- E. Applicant request/plans

cc: Mike Zislis, Applicant

Vicinity Map  
**117 Manhattan Beach Blvd.**

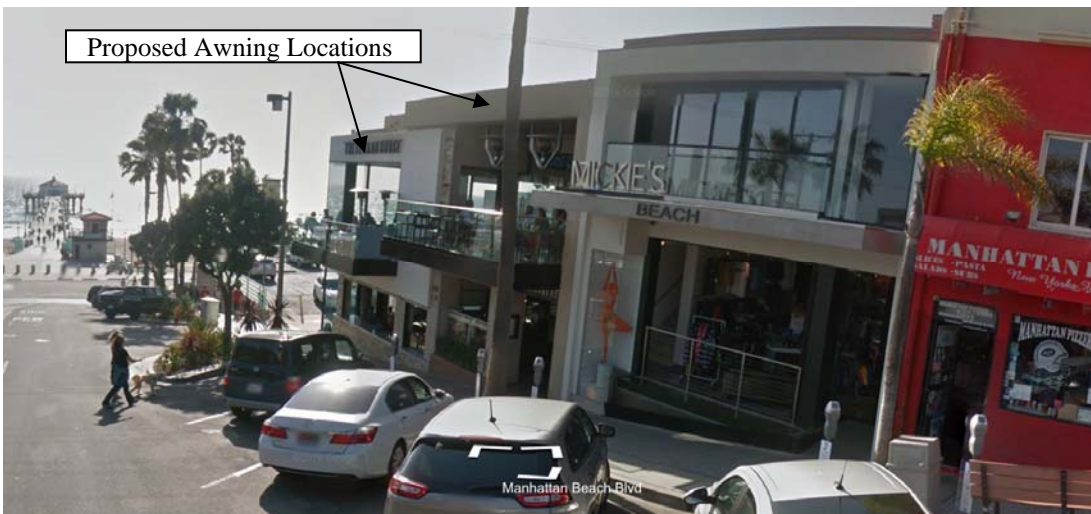

THIS PAGE

INTENTIONALLY

LEFT BLANK

1  
2  
3  
4  
5  
6  
7  
8  
9  
10  
11  
12  
13  
14  
15  
16  
17  
18  
19  
20  
21  
22  
23  
24  
25  
26  
27  
28  
29  
30  
31  
32

RESOLUTION NO. 6304

A RESOLUTION OF THE CITY COUNCIL OF THE CITY OF MANHATTAN BEACH, CALIFORNIA, APPROVING AN ENCROACHMENT PERMIT REQUEST FOR AN EXISTING RESTAURANT BUILDING ON THE PROPERTY LOCATED AT 117 MANHATTAN BEACH BOULEVARD IN THE CITY OF MANHATTAN BEACH (MB Dining LLC/Strata)

THE CITY COUNCIL OF THE CITY OF MANHATTAN BEACH, CALIFORNIA, DOES HEREBY RESOLVE AS FOLLOWS:

SECTION 1. The City Council of the City of Manhattan Beach hereby makes the following findings:

- A. The City Council conducted a public hearing on the proposed restaurant remodel project that included a request for 5-foot wide dining balconies, and testimony was invited and received, on April 5, 2011.
- B. The applicant for the use permit amendment and encroachment permit is MB Dining LLC/Strata.
- C. A commercial dining balcony encroachment requires separate City Council approval pursuant to Section 7.36.170 M.B.M.C. The applicant appealed the Planning Commission's approval of February 23, 2011, in order to obtain the special encroachment approval from the City Council.
- D. The City Council, at its regular meeting of April 5, 2011, conducted an appeal hearing, approved the use permit amendment for the restaurant remodel, and indicated support for the special encroachment request for two 5-foot wide balconies, and directed that a resolution for encroachment approval be prepared.
- E. The Planning Commission and City Council determined that a coastal development permit is not required for the project, since it consists of an alteration to an existing restaurant building with no change in land use intensity.
- F. The project is Categorically Exempt (Class 1, Section 15301) from the requirements of the California Environmental Quality Act (CEQA) since it involves minor modification of an existing facility.
- G. The project will not individually nor cumulatively have an adverse effect on wildlife resources, as defined in Section 711.2 of the Fish and Game Code.
- H. The proposed encroachment, as conditioned herein, shall be implemented by issuance of an Encroachment Permit by the Community Development Director subject to the appropriate procedures, as it is in accordance with the encroachment objectives of the Manhattan Beach Municipal Code as follows:
  - a) The permit will not be materially detrimental to the public health, safety, convenience, and welfare or injurious to property and improvements in the same vicinity and zone in which the property is located; since sidewalk dining is permitted in the right of way, and a similar size balcony projection is located adjacent to the project.
  - b) The granting of the encroachment permit will be in conformity with the policies and goals of the General Plan.
  - c) The proposed encroachment will comply with the provisions of MBMC Chapter 7.36, including any conditions required.

- d) The proposed encroachment will not encroach into the area of the right of way occupied by an improved paved sidewalk or pedestrian or vehicular accessway or stairway, since the balconies will be above the public sidewalk in conformance to Building Code standards for vertical clearances.
- e) The proposed encroachment will not reduce or adversely impact public pedestrian access along the paved and improved portion of the sidewalk, walk street, alley or stairway and does not reduce or adversely impact the vehicular access along the improved alley since the balconies will be above the public sidewalk in conformance to Building Code standards for vertical clearances.
- f) The proposed encroachment will not impact public access to the shoreline, adequate public access is provided and shall be maintained in the public right of way adjacent to the subject property since the balconies will be above the public sidewalk in conformance to Building Code standards for vertical clearances.
- g) The present and foreseeable future demand for public or commercial recreational activities that could be accommodated on the property is already adequately provided for in the area as the Manhattan Beach Boulevard roadway is built to its full width, and there is no anticipated need for widening.

SECTION 2. The City Council of the City of Manhattan Beach hereby approves the request for a dining balcony encroachment into the Manhattan Beach Boulevard right of way for an existing restaurant building, subject to the following conditions:

1. The project shall be in substantial conformance with the plans submitted to, and approved by the City Council, on April 5, 2011.
2. The project shall conform to the procedures and standards of the Manhattan Beach Municipal Code, Manhattan Beach Local Coastal Program, and California Building Code.
3. No sidewalk dining or other normally permitted encroachments shall be permitted while the balcony encroachments are in place.

SECTION 3. Pursuant to Government Code Section 65907 and Code of Civil Procedure Section 1094.6, any action or proceeding to attack, review, set aside, void or annul this decision, or concerning any of the proceedings, acts, or determinations taken, done or made prior to such decision or to determine the reasonableness, legality or validity of any condition attached to this decision shall not be maintained by any person unless the action or proceeding is commenced within 90 days of the date of this resolution and the City Council is served within 120 days of the date of this resolution. The City Clerk shall send a certified copy of this resolution to the applicant, and if any, the appellant at the address of said person set forth in the record of the proceedings and such mailing shall constitute the notice required by Code of Civil Procedure Section 1094.6.

SECTION 4. This resolution shall take effect immediately. The City Clerk shall make this resolution readily available for public inspection within thirty (30) days of the date this resolution is adopted.

SECTION 5. The City Clerk shall certify to the adoption of this resolution and thenceforth and thereafter the same shall be in full force and effect.

PASSED, APPROVED and ADOPTED this 19th day of April, 2011.

Ayes: Powell, Howorth, Tell and Mayor Montgomery.  
Noes: None.  
Absent: None.  
Abstain: Lesser.

PASSED, APPROVED and ADOPTED this 19th day of April, 2011.

- 1
- 2
- 3
- 4
- 5
- 6
- 7
- 8
- 9
- 10
- 11
- 12
- 13
- 14
- 15
- 16
- 17
- 18
- 19
- 20
- 21
- 22
- 23
- 24
- 25
- 26
- 27
- 28
- 29
- 30
- 31
- 32

Ayes: Powell, Howorth, Tell and Mayor Montgomery.  
 Noes: None.  
 Absent: None.  
 Abstain: Lesser.

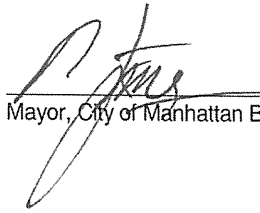
  
 \_\_\_\_\_  
 Mayor, City of Manhattan Beach, California

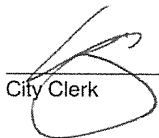
ATTEST:  
  
 \_\_\_\_\_  
 City Clerk

1  
2  
3  
4  
5  
6  
7  
8  
9  
10  
11  
12  
13  
14  
15  
16  
17  
18  
19  
20  
21  
22  
23  
24  
25  
26  
27  
28  
29  
30  
31  
32

STATE OF CALIFORNIA )  
 )  
COUNTY OF LOS ANGELES ) SS.  
 )  
CITY OF MANHATTAN BEACH )

I, Liza Tamura, City Clerk of the City of Manhattan Beach, California, do hereby certify that the whole number of members of the City Council of said City is five; that the foregoing resolution, being Resolution No. 6304 duly and regularly introduced before and adopted by the City Council of said City at a regular meeting of said Council, duly and regularly held on the 5<sup>th</sup> day of April, 2011 and that the same was so passed and adopted by the following vote, to wit:

Ayes: Powell, Howorth, Tell and Mayor Montgomery.  
Noes: None.  
Absent: None.  
Abstain: Lesser.

IN WITNESS WHEREOF, I have hereunto subscribed my name and affixed the official seal of said City this 11<sup>th</sup> day of April, 2011.

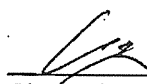
  
\_\_\_\_\_  
City Clerk of the City of  
Manhattan Beach, California

(SEAL)





Agenda Item #: \_\_\_\_\_

# Staff Report

## City of Manhattan Beach

**TO:** Honorable Mayor Montgomery and Members of the City Council

**THROUGH:** David N. Carmany, City Manager

**FROM:** Richard Thompson, Director of Community Development  
Eric Haaland, Associate Planner

**DATE:** April 19, 2011

**SUBJECT:** Consideration of an Encroachment Permit for Outdoor Dining Over the Sidewalk at 117 Manhattan Beach Boulevard.

---

**RECOMMENDATION:**

Staff recommends that the City Council adopt Resolution No. 6304 approving the request for an Encroachment Permit for outdoor dining above the public sidewalk and receive and file this report.

**FISCAL IMPLICATION:**

The City will charge rent for commercial use of the public right-of-way consistent with previous examples of permanently encroaching restaurant dining.

**DISCUSSION:**

The City Council, at its regular meeting of April 5, 2011, approved (3-0 vote, 1 abstention-Lesser, 1 absent-Tell) a use permit amendment to remodel an existing 6,750 square foot restaurant building with some business operational changes. Additionally, the City Council granted the applicant's request for two dining balconies extending 5 feet into the public right-of-way above the Manhattan Beach Boulevard sidewalk. The Planning Commission had approved the project, but the City Council must approve this type of encroachment, which is not a routinely permitted type of commercial encroachment such as awnings and canopies over the sidewalk.

Staff has provided the attached resolution for the City Council's formal approval of the special encroachment, which will allow the Community Development Department to issue an encroachment permit for balcony construction, indemnification, and insurance.

**ALTERNATIVES:**

The alternatives to the staff recommendation include:

1. Remove the item from the Consent Calendar, modify the proposed resolution, and approve the encroachment.

Attachments:

- A. Resolution No. 6304
- B. Balcony plan excerpt

cc: Michael Zislis, Applicant Representative

# 117 Manhattan Beach Blvd Appeal

## 5-Foot Wide Balcony Dining Encroachments

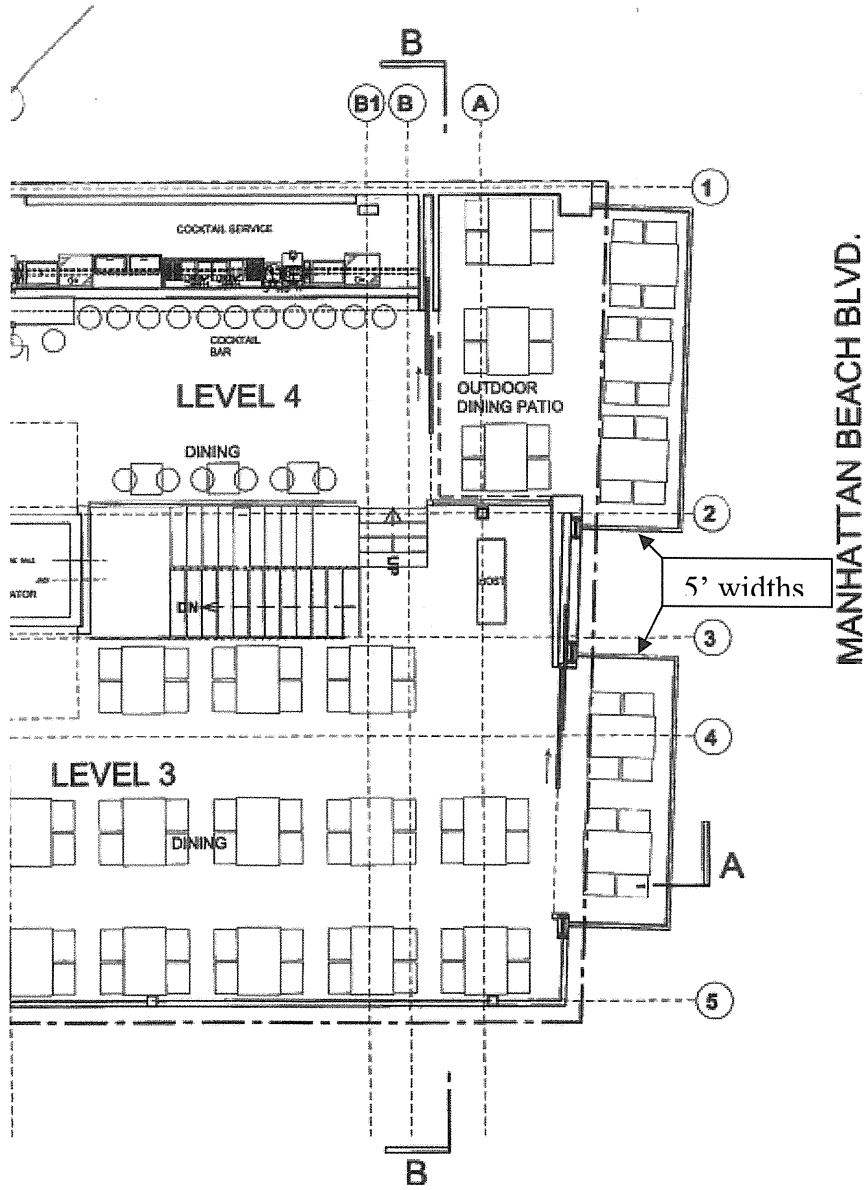

THIS PAGE

INTENTIONALLY

LEFT BLANK



Agenda Item #: \_\_\_\_\_

# Staff Report

## City of Manhattan Beach

**TO:** Honorable Mayor Montgomery and Members of the City Council

**THROUGH:** David N. Carmany, City Manager

**FROM:** Richard Thompson, Director of Community Development  
Eric Haaland, Associate Planner

**DATE:** April 5, 2011

**SUBJECT:** Consideration of Two Appeals of the Planning Commission's Decision to Approve a Use Permit for Strata to Remodel an Existing Restaurant, Provide Outdoor Seating, and Expand Operating and Entertainment Hours and Consideration of an Encroachment Permit for Outdoor Dining Over the Sidewalk at 117 Manhattan Beach Boulevard.

---

### **RECOMMENDATION:**

Staff recommends that the City Council uphold the decision of the Planning Commission approving the request, and consider the request for an Encroachment Permit for outdoor dining above the public sidewalk.

### **FISCAL IMPLICATION:**

There are no fiscal implications associated with the recommended action.

### **DISCUSSION:**

The Planning Commission, at its regular meeting of March 9, 2011, approved (4-0 vote, 1 abstention) a request to remodel an existing 6,750 square foot restaurant building with some business operational changes. The existing building was constructed near the 26-foot height limit, and at the 1.5 floor area ratio limit, with 4 on-site parking spaces.

The proposal is for the building's existing 4 floor levels to be modified, and the addition of a new partial basement level for wine storage, rear employee restroom and locker facilities, and two new upper level dining balconies over Manhattan Beach Boulevard. Substantial upgrades are proposed for kitchen capacity, health codes, building codes, utilities, disabled access, ventilation, sound containment, and trash storage. Additional changes to the building include recessions of the front walls to provide outdoor dining, waiting, and entry areas; and the retractable windows to allow the restaurant to open to Manhattan Beach Boulevard during good weather. The applicant also proposes modifying the restaurant's hours of operation, entertainment and dancing.

Use Permit Amendment approval is required for the applicant's proposals to create outdoor dining/seating, change hours of operation, allow additional nights of dancing, relocate/modify the dance floor, and to install retractable walls/windows at the building frontage.

The Planning Commission received letters and testimony from neighbors stating concerns for noise and other disruptions that could occur from modified hours, dancing, and openness of the building. The Commission also had concerns for these issues, requesting additional information from the applicant and suggesting possible ongoing review of sensitive aspects of the business. The applicant subsequently eliminated the retractable window design from the uppermost level of the building opening onto the outdoor dining patio; and provided a formal noise analysis and further explanations of sound mitigating materials to be used in the building remodel. Staff recommended conditions extending the authority of the restaurant's required annual Entertainment Permit to regulate the noise caused by the openings, and to reduce entertainment and dancing if needed. At the continued public hearing the Planning Commission generally accepted these conditions, and accepted an agreement between the applicant and neighbor representatives regarding hours and dancing. The final approved resolution (Exhibit A) included the following changes to the existing Use Permit:

- **Dancing** was added for Thursdays and Sundays with the restriction that it end by 11:30pm on those nights. The current Use Permit only allows entertainment without dancing, with hours until 1:00am on Sunday and 11:30pm on Thursday.
- **Closing times** for Sunday – Thursday were reduced from 1am to midnight to compensate for the added dancing as agreed upon with neighbor representatives.
- **Opening times** for holidays were extended from 10am to 8am to allow breakfast service similar to existing weekend entitlements.
- **Delivery hours** were restricted to 8am to 10pm to compensate for the added breakfast hours. Currently there are no restrictions.
- **Noise at non-entertainment times** (when windows/walls are permitted to be kept open) was made subject to an annual entertainment permit when windows/walls can be opened.
- **Noise at all times** was prohibited from being audible more than 75 feet away from the restaurant as recommended by the Police Department.
- **Encroachments** of 18-inch deep architectural “false balcony” features over the Manhattan Beach Boulevard right-of-way, instead of the originally requested dining balconies over the sidewalk were proposed by the applicant. The Commission does not have authority to approve a balcony encroachment, and could not reach a consensus recommendation on this issue.
- Updated/miscellaneous Use Permit conditions were imposed regarding utilities, use of rear roof area, and supervising the surrounding area.

Applications appealing the Planning Commission's decision were received from the project applicant, and a resident who participated in the public hearing. The attached applicant appeal request is to permit 5-foot wide balcony dining encroachments over the sidewalk with 200 square feet of area, and 24 seats. The resident appeal opposes expansion of “nightclub” aspects of the business.

The applicant had proposed two balconies partially cantilevering over the public sidewalk. Commercial encroachments over sidewalks are limited to canopies, signs, eaves, and awnings with

Director of Community Development approval. Other commercial use of the public right-of-way requires City Council approval pursuant to Municipal Code Section 7.36.100. The Planning Commission had concerns with allowing restaurant dining above the public sidewalk, and was also hesitant to establish a precedent for restaurant patrons to be located directly above public sidewalks creating a street dynamic that may be disruptive or otherwise undesirable. The applicant's appeal letter (attached) requests the Council to approve 5-foot deep balcony encroachments to compensate for existing dining area displaced by kitchen and other support upgrades to the restaurant. The applicant points out that a somewhat similar encroachment example exists in that the neighboring building to the east has a 5-foot balcony, which appears on its original 1971 plans, apparently for incidental purposes to an office use. No right-of-way encroachment approval was found for this item.

The attached resident appeal material states that the project overemphasizes alcohol and entertainment components of the restaurant use. The document lists concerns for noise, parking, closing procedures, environmental documentation, and coastal regulations. The Planning Commission felt that: noise was adequately addressed as discussed above, no additional parking is required since there is no increase in dining area, and the project is exempt from extensive environmental review as an alteration of an existing use. Staff had initially determined the project is exempt from a Coastal Development Permit as a continuation of an existing restaurant use, but has subsequently learned that the site is regulated by a 1983 State-issued coastal permit, and any further coastal permit requirement determinations must be made by the California Coastal Commission.

Coastal Development Permit:

The project is located within the appealable portion of the City's coastal zone. A coastal development permit required for a substantial development at this location would be appealable to the California Coastal Commission after City Council's decision. Staff had determined that the project was exempt from a coastal permit since the restaurant land use would remain essentially the same, and the building would not become any larger, or significantly smaller. The resident appellant disagrees with this exemption determination feeling that changing dancing and hours of operation significantly change the land use.

Subsequent to the Planning Commission's meeting, Staff has learned that the building has a pre-existing permit for an addition/remodel issued by the Coastal Commission in 1983 prior to the City's Local Coastal Program. Section A.96.080 of the Local Coastal Program states that pre-existing permits such as this "remain under the jurisdiction of the Commission". In this case the Coastal Commission would process a coastal permit amendment or exempt the project after the City's action. Staff's understanding at this time is that allowing the Coastal Commission to make that determination is the appropriate procedure.

Environmental Review:

Since the project involves discretionary review, it is subject to the California Environmental Quality Act (CEQA), which can involve extensive procedures and documentation. Section 15301 of CEQA states that alterations to existing facilities are exempt from those procedures, including additions up to 2,500 square feet. The City Attorney explained to the Planning Commission that the City could determine that the project is not exempt if an environmental impact was believed to be present, but the Planning Commission did not find this to be the case.

Use Permit Findings:

Section 10.84.010 of the Zoning Code establishes that the purpose of Use Permits is as follows:

Use permits are required for use classifications typically having unusual site development features or operating characteristics requiring special consideration so that they may be designed, located, and operated compatibly with uses on adjoining properties and in the surrounding area.

Section 10.84.020 states that “The Planning Commission shall approve, conditionally approve, or disapprove applications for use permits or variances”.

Pursuant to Section 10.84.060 the City Council is required to make certain findings in order to approve the proposed use permit as follows:

1. The proposed location of the use is in accord with the objectives of this title and the purposes of the district in which the site is located;
2. The proposed location of the use and the proposed conditions under which it would be operated or maintained will be consistent with the General Plan; will not be detrimental to the public health, safety or welfare of persons residing or working on the proposed project site or in or adjacent to the neighborhood of such use; and will not be detrimental to properties or improvements in the vicinity or to the general welfare of the city;
3. The proposed use will comply with the provisions of this title, including any specific condition required for the proposed use in the district in which it would be located; and
4. The proposed use will not adversely impact nor be adversely impacted by nearby properties. Potential impacts are related but not necessarily limited to: traffic, parking, noise, vibration, odors, resident security and personal safety, and aesthetics, or create demands exceeding the capacity of public services and facilities which cannot be mitigated.

Section 10.84.070 provides that reasonable conditions may be imposed upon a Use Permit as necessary to:

- A. Achieve the general purposes of this ordinance or the specific purposes of the zoning district in which the site is located, or to make it consistent with the General Plan;
- B. Protect the public health, safety, and general welfare; or
- C. Ensure operation and maintenance of the use in a manner compatible with existing and potential uses on adjoining properties or in the surrounding area.
- D. Provide for periodic review of the use to determine compliance with conditions imposed, and Municipal Code requirements.

The Planning Commission made these required findings and imposed conditions it felt were reasonable to meet the Code criteria.

Balcony Encroachment

The applicant’s proposal for two balconies partially cantilevering over the public sidewalk is



unique, although the neighboring building to the east has a 5-foot balcony for an office use. Currently, allowance for commercial encroachments over sidewalks has been limited to signs, canopies, and awnings projecting 3 feet over City right-of-way. The Planning Commission discussed concerns regarding disruption and safety to the street below, permanence, visual compatibility, view obstruction, equity, and setting a precedent for similar future requests. The Commission could not determine that the balcony dining was appropriate. The applicant is requesting the City Council to approve the balconies with dining area based on facts that dining area is being lost as part of the overall restaurant upgrade, and that sidewalk dining is commonly permitted at ground level Downtown.

The Land Use Element of the Manhattan Beach General Plan supports the visual aspect of the proposed balconies by encouraging development to have “notches, balconies, rooflines, open space, setbacks, landscaping, or other architectural details”. Infrastructure Element Policy I-1.10 directs that the City “adopt and implement standards for public street right-of-way for private purposes”. This was accomplished by updating Chapter 7.36 of the Municipal Code, which contains relevant Section 7.36.170 providing that City Council must approve non-standard commercial encroachments, and prohibiting commercial use of walk street right-of-way.

Staff has contacted some other cities and found that Hermosa Beach, Redondo Beach, and Huntington Beach would not permit any such encroachments. Carlsbad indicated that ground level dining encroachments are common in its downtown area, but balcony encroachments would not be permitted. Each of these cities had the option of applying/appealing to City Council for such a request. New Orleans, Louisiana, which is well known for balcony encroachments, indicated they are common, and are primarily handled as complex long term leases through the City’s “Office of Property Management”. The City of Santa Monica’s website makes reference to balcony encroachments, and that City’s staff indicated that they are permitted.

The portion of the building facing Manhattan Beach Boulevard is set back ten inches from the property line where the two balconies are proposed. The sidewalk is 8 feet wide. The City Council may wish to discuss the following dimensional options:

1. A 1’ balcony projection for architectural purposes only, which results in a 2” encroachment over the sidewalk.
2. A 2’- 4” balcony projection, which results in an 18” encroachment over the sidewalk.
3. A 3’-10” balcony projection, which results in a 3’ encroachment over the sidewalk.
4. A 5’-10” balcony projection, which results in a 5’ encroachment over the sidewalk.

Public Input:

Staff received one message in response to the appeal hearing notice requesting additional consideration of roof equipment design and screening. Some discussion had occurred regarding preserving neighbors views when locating new roof equipment on the building, and potentially reducing screening requirements in favor of preserving these views. The applicant has indicated agreement to the attached neighbor suggestion. Staff suggests that equipment be visually screened, especially since this building is prominently visible from the public beach and pier, and will work with the applicant and neighbor to balance these concerns.

**CONCLUSION**

Staff recommends that the City Council conduct the appeal hearing, discuss testimony received, and uphold the Planning Commission's decision approving the proposed restaurant remodel with certain operational changes, subject to conditions listed in Planning Commission Resolution No. PC 11-02 (Exhibit A). If the City Council determines that the requested balcony dining, or architectural projection encroachments are appropriate, staff will prepare a modified use permit, or separate resolution reflecting that decision, and will subsequently issue the related encroachment permit.

**ALTERNATIVES:**

The alternatives to the staff recommendation include:

1. Conduct the public hearing, uphold the Planning Commission's use permit approval subject to conditions, and approve an 18-inch architectural projection without dining area over the right-of-way encroachment.
2. Conduct the public hearing and direct Staff and the Applicant regarding the use permit and encroachment proposals as determined to be appropriate.

Attachments:

- A. Resolution No. PC 11-02
- B. P.C. Minutes excerpts, dated 1/26/11 & 2/23/11
- C. P.C. Staff Reports and attachments, dated 1/26/11 & 2/23/11
- D. Applicant appeal material
- E. Resident appeal material
- F. Neighbor letter
- G. Existing 1983 State coastal permit
- H. Commercial encroachment code
- I. Project plans (separate-not available electronically)

cc: Michael Zislis, Appellant/Applicant Representative  
Don McPherson, Appellant

7.36.170 - Long-term commercial use encroachment permits.

A. Commercial use of the public right of way requires City Council approval.

Exceptions. The Director of Community Development may approve the following:

- a. Sidewalk dining permits applicable to vehicular streets in conformance with Section 7.36.110 of this chapter.
- b. Building projections such as eaves, awnings, signs or elements that benefit the public and comply with applicable codes.
- c. Roof access or other elements for existing buildings that are required by applicable codes, when alternative on-site locations are not feasible.

B. Commercial use of a walk street is prohibited. Existing long-term uses conducted on a walk street under the authority of an Encroachment Permit approved prior to January 21, 2003 may continue to operate provided the use is not expanded or intensified. Expansion of intensification includes but is not necessarily limited to: increase of floor area or expansion of hours of operation, or addition of alcohol beverage service.

(§ 1, Ord. 2039, eff. February 18, 2003)

THIS PAGE

INTENTIONALLY

LEFT BLANK

Extra set  
Applicant  
material

# THE STRAND HOUSE®

July 6, 2016

The Strand House  
117 Manhattan Beach Blvd  
Manhattan Beach, CA 90266

To Whom It May Concern:

I am requesting the addition of awnings over the two existing balconies at The Strand House at 117 Manhattan Beach Blvd. Currently, umbrellas are used but they can be dangerous and blow away in windy conditions. The addition of awnings is a smarter and safer design.

Regards,



Michael Zislis  
Owner  
310-704-8507



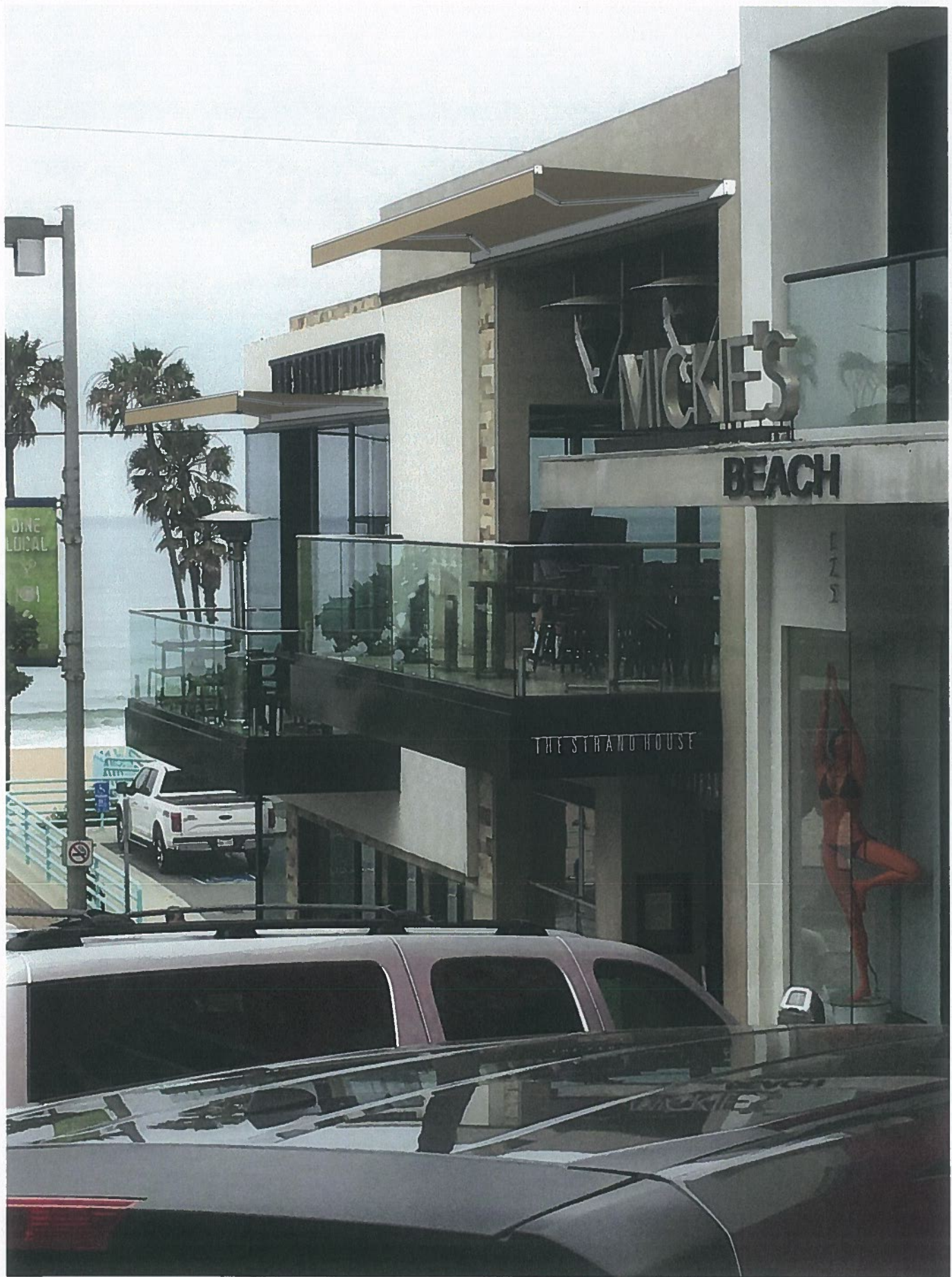



**THE STRAND HOUSE  
FABRIC AWNING ANCHORAGE**

**117 MANHATTAN BEACH BLVD  
MANHATTAN BEACH, CA 90266  
[INSIGHT PROJECT #16016]**

***ISSUE FOR PLAN CHECK***

January 28, 2016

**TABLE OF CONTENTS**

<u>Description</u>	<u>Pages</u>
Partial Plan	SK-1
Section at Existing Stud	SK-2
Section at Existing Header	SK-3







Structural Engineers

Job: THE STRAND HOUSE

Subject: PARTIAL PLAN

Job Number: 16016

Date: 1/28/16

By: BL

Section:

Checked By:

Page: 1 of 3

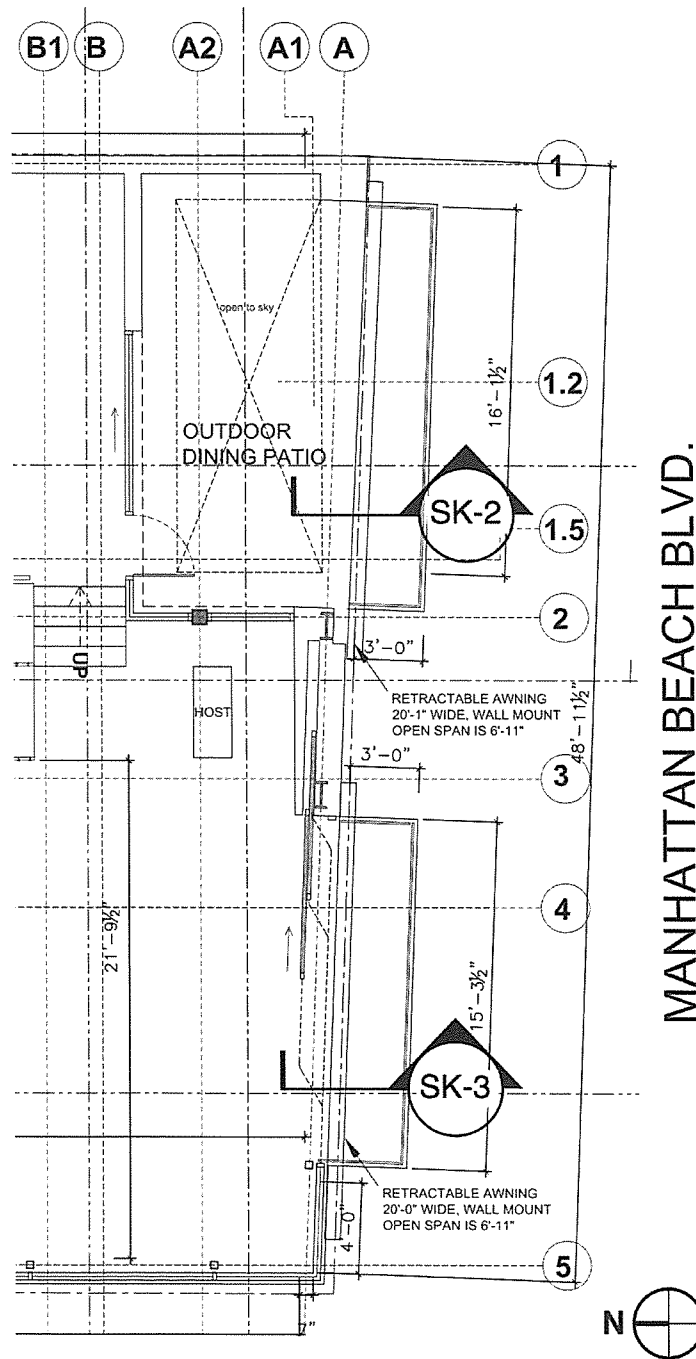

SK-1

# PARTIAL PLAN

N.T.S.



Structural Engineers

Job: STRAND HOUSE AWNINGS

Subject:

Job Number: 16016

Date: 1/28/16

By: BL

Section:

Checked By:

Page: 3 of 3

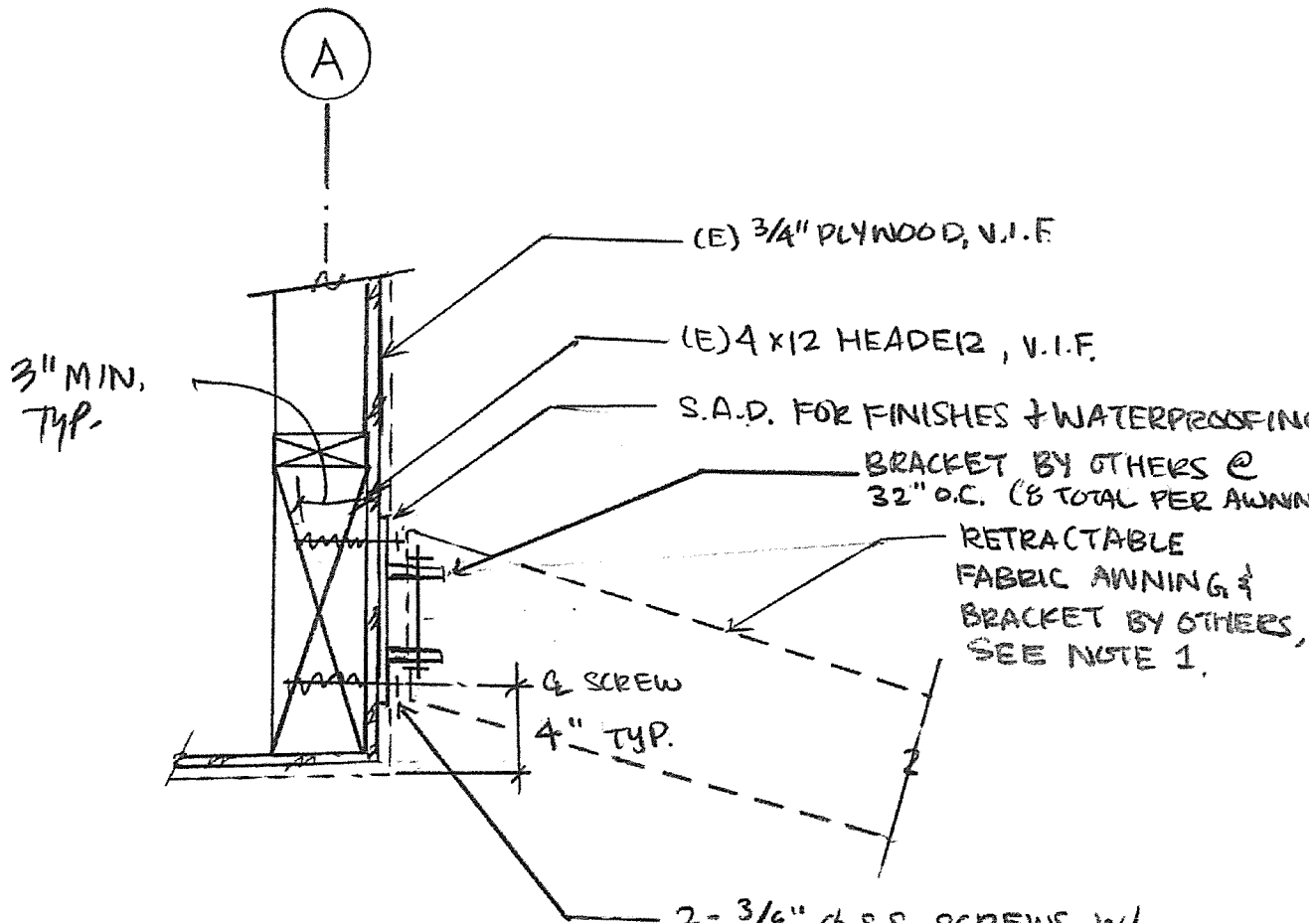

NOTE:

1. FABRIC AWNING WEIGHT NOT TO EXCEED 1.5 PSF (INCLUDING FABRIC, TRACK, RETRABLE ARMS, ETC)
2. LAG SCREWS TO BE TYPE 316 STAINLESS STEEL
3. PROVIDE WATERPROOFING AS REQ'D.

2 - 3/8"  $\phi$  S.S. SCREWS W/  
3" MIN EMBED, SEE  
SK-2 FOR INFO NOT SHOWN.

SK-3

SECTION @ (E) HEADER

N.T.S.



Structural Engineers

Job: STRAND HOUSE AWNINGS  
 Subject: \_\_\_\_\_

Job Number: 16016 Date: 1/28/16  
 By: BL Section: \_\_\_\_\_  
 Checked By: \_\_\_\_\_ Page: 2 of 3

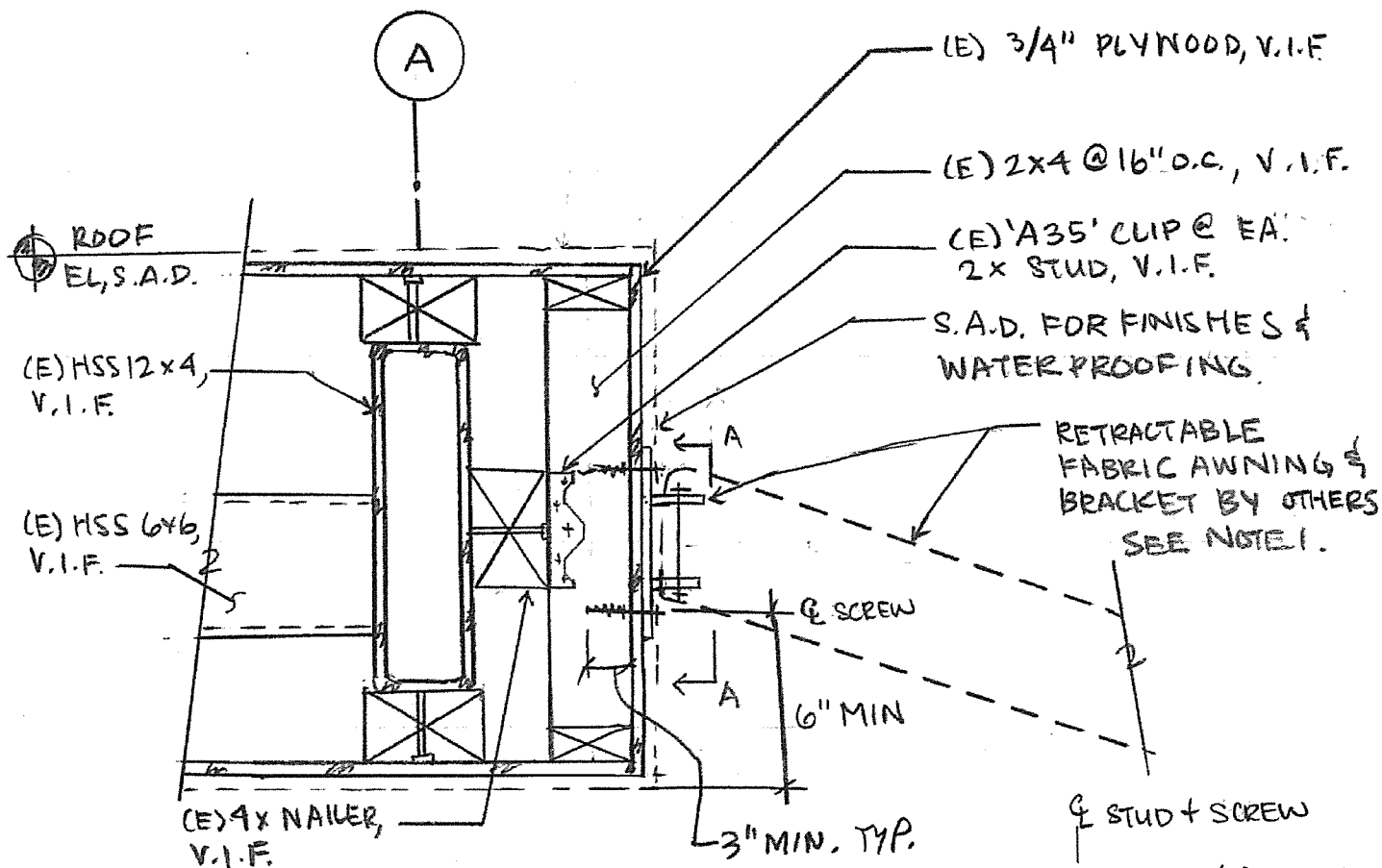

**NOTE:**

1. FABRIC AWNING WEIGHT NOT TO EXCEED 1.5 PSF (INCLUDING FABRIC, TRACK, RETRACTABLE ARMS, ETC)
2. LAG SCREWS TO BE TYPE 316 STAINLESS STEEL
3. PROVIDE WATERPROOFING AS REQ'D.

2- 3/8"  $\phi$  S.S. SCREWS W/ 3" MIN. EMBED. INTO WOOD BRACKET PER MANUFACTURER @ 32" O.C (1/8" TOTAL PER AWNING)

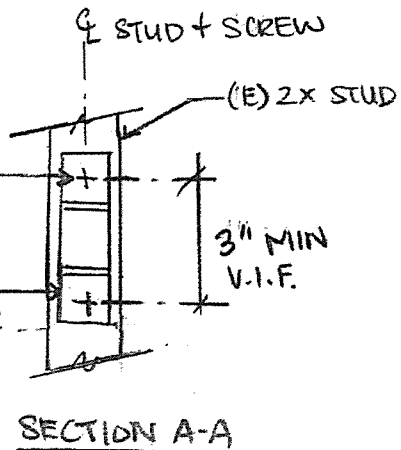

**SK-2** SECTION @ (E) STUD  
 N.T.S.

**TENDE A BRACCI ESTENSIBILI**

Folding arm awnings  
Store à bras extensibles  
Gelenkarm-Markisen  
Toldos de brazos extensibles



**AUSTRALIA  
R-PITCH**



awning the Italian way

# AUSTRALIA R-90

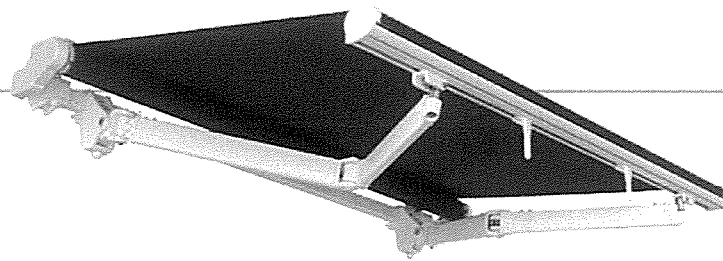

■ ■ ■  
R - 90 è una tenda a bracci estensibili su barra quadrata 40 mm in acciaio zincato e verniciato con bracci a doppio cavetto inguainato o a catena inox e supporto braccio a cremagliera con inclinazione singola di ogni braccio. Tenda modulare: aggiungendo ulteriori profili si possono raggiungere misure diverse. Il terminale frontale è intercambiabile con quelli del catalogo BAT. Dispone come optional di un tettuccio di copertura in alluminio estruso e di una staffa speciale per il montaggio sottotetto.

■ ■ ■  
R - 90 is a folding arm awning on 40 mm galvanized and painted steel square bar with double covered cable or stainless chain arms and gear rack extruded arm support with inclination adjustment on the single arm. The awning is modular and larger sizes can be reached joining more profiles together. The front terminal bar is interchangeable with those in the BAT catalogue. A protection hood in extruded aluminium, a special bracket for under-roof mounting and a balance support are also available.

■ ■ ■  
R - 90 est un store banné à bras extensibles monté sur barre carrée 40 mm zinguée et laquée, avec bras à double câbles gainés ou chaîne inox avec un support bars à crémaillère pour le réglage individuel de chaque bras. La barre de charge est interchangeable parmi celles disponibles dans le catalogue BAT. Il existe aussi un auvent de protection et un support pour la pose sous-toit.

■ ■ ■  
R - 90: Gelenkarm-Markise mit 40 mm verzinktem und lackiertem Tragrohr, Doppelseil- oder rostfreier Kettenarm. Die Neigung kann mittels den Armlagern individuell verstellt werden. Das Ausfallprofil ist mit anderen Fallstangen aus dem BAT-Sortiment austauschbar. Zusätzlich ist ein stranggepresstes Aluminium-Schutzdach erhältlich sowie spezielle Dachkonsolen.

■ ■ ■  
R - 90 es un toldo con brazos extensibles sobre barra cuadrada 40 mm en acero galvanizado con brazos a doble cable enfundado o con cadena acero inox y soporte brazo con cremallera con inclinación singular de cada brazo. Es un toldo modular: agregando posteriores perfiles se puede alcanzar un largo mayor. El terminal frontal es intercambiable con los otros terminales BAT. Dispone como opcional un tejadillo en aluminio extruido y soporte especial para el montaje bajo techo.

# AUSTRALIA R-PITCH

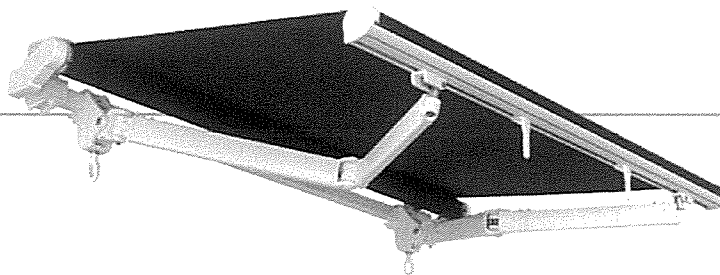

■ ■ ■  
R - PITCH è una tenda a bracci estensibili su barra quadrata 40 mm in acciaio zincato e verniciato con bracci a doppio cavetto inguainato o a catena inox e supporto braccio a cremagliera con inclinazione singola di ogni braccio. Tenda modulare: aggiungendo ulteriori profili si possono raggiungere misure diverse. Il terminale frontale è intercambiabile con quelli del catalogo BAT. Dispone come optional di un tettuccio di copertura in alluminio estruso e di una staffa speciale per il montaggio sottotetto.

■ ■ ■  
R - PITCH is a folding arm awning on 40 mm galvanized and painted steel square bar with double covered cable or stainless chain arms and gear rack extruded arm support with inclination adjustment on the single arm. The awning is modular and larger sizes can be reached by adding more profiles together. The terminal bar is interchangeable with those in the BAT catalogue. A protection hood in extruded aluminium, a special bracket for under-roof mounting and a balance support are also available.

■ ■ ■  
R - PITCH est une store banné à bras extensibles monté sur barre carrée 40 mm zinguée et laquée, avec bras à double câbles gainés ou chaîne inox avec un support bars à crémaillère pour le réglage individuel de chaque bras. La barre de charge est interchangeable parmi celles disponibles dans le catalogue BAT. Il existe aussi un auvent de protection et un support pour la pose sous-toit.

■ ■ ■  
R - PITCH: Gelenkarm-Markise mit 40 mm verzinktem und lackiertem Tragrohr, Doppelseil- oder rostfreiem Kettenarm. Die Neigung kann mittels den Armlagern individuell verstellt werden. Die Breite ist je nach Belleben wählbar. Das Ausfallprofil ist mit anderen Fallstangen aus dem BAT-Sortiment austauschbar. Zusätzlich ist ein stranggepresstes Aluminium-Schutzdach erhältlich sowie spezielle Dachkonsolen.

■ ■ ■  
R - PITCH es un toldo con brazos extensibles sobre barra cuadrada 40 mm en acero galvanizado con brazos a doble cable enfundado o con cadena acero inox y soporte brazo con cremallera con inclinación singular de cada brazo. Es un toldo modular: agregando posteriores perfiles se puede alcanzar un largo mayor. El terminal frontal es intercambiable con los otros terminales BAT. Dispone como opcional un tejadillo en aluminio extruido y soporte especial para el montaje bajo techo.

# AUSTRALIA R-90



## SCHEMA TECNICA/technical sheet

### Diagramma di copertura - Installazione parete e soffitto Covering diagram - Wall and ceiling installation

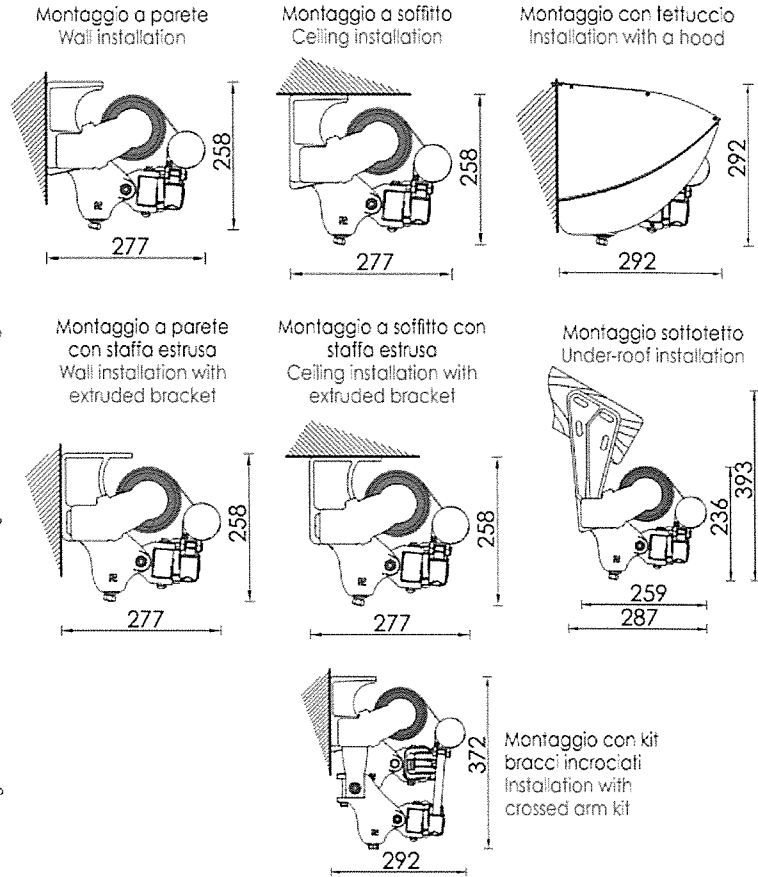
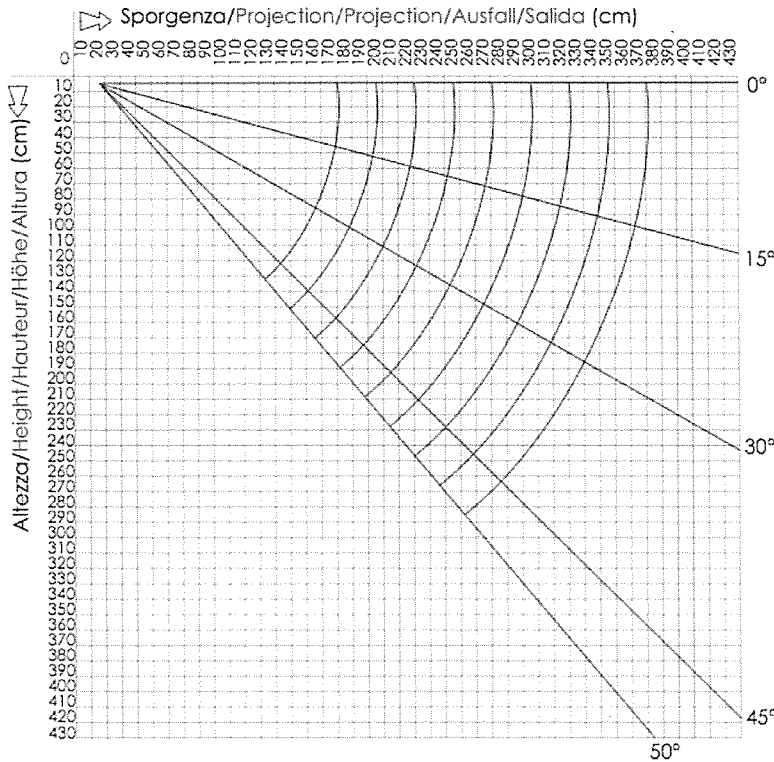

### Dimensioni massime - Maxi dimensions

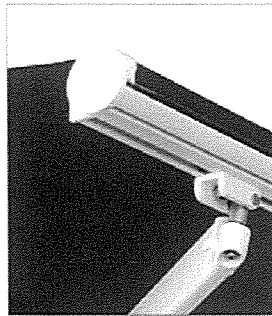
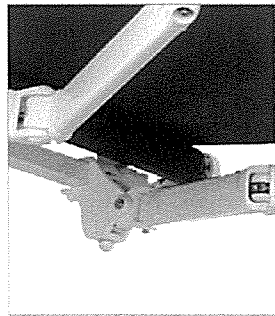
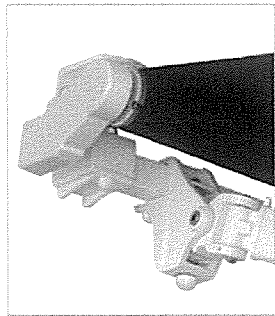

Tutte le misure dei montaggi sono espresse in mm \ All the sizes are in mm \ Tout dimension en mm  
Alle Massen in den Montagschemen verstehen sich in mm \ Todas las dimensiones están en mm accesorios

Ingombri minimi della tenda finita - 1 coppia bracci  
Minimum awning encumbrances - 1 pair arms  
Encombrenents minimum du store fini - 1 pair bras  
Mindestabmessungen der Markise - 1 Paar Gelenkarne  
Tamaño mínimo del toldo - 1 pareja de brazos

Sporgenza Projection Avancée Ausladung Salida	Larghezza min. Min. Width Largeur min. Breite min. Linea min.	Largh. min. con kit bracci incrociati Min. Width with crossed arms Largeur min. avec bras croisés Breite min. mit gekreuzte arme Linea min. con brazos cruzados
160	191	129
185	216	141
210	241	154
235	266	166
260	291	179
285	316	191
310	341	204
335	366	216
360	391	229